

PLANK 1





















CODE	COULEUR	KLEUR	FARBE	COLOR	AC	LED	T° (K)	LED Lumen
PK30/1A/3K/W	BLANC MAT	MAT WIT	WEISS MATT	MATT WHITE	AC 230V	20W	3000K	2520 Lm
PK30/1A/4K/W	BLANC MAT	MAT WIT	WEISS MATT	MATT WHITE	AC 230V	20W	4000K	2730 Lm
PK60/1A/3K/W	BLANC MAT	MAT WIT	WEISS MATT	MATT WHITE	AC 230V	40W	3000K	5400 Lm
PK60/1A/4K/W	BLANC MAT	MAT WIT	WEISS MATT	MATT WHITE	AC 230V	40W	4000K	5850 Lm

F Ce produit contient 1 source(s) lumineuse(s) d'efficacité énergétique E.

D Dieses Produkt enthält 1 Lichtquelle(n) mit E energieeffizient.

N Dit product bevat 1 lichtbron(nen) energiezuinig E.

E This product contains 1 light source(s) of energy efficiency E.

F	N	D	E
 Montage sur un mur uniquement.	Wandmontage alleen.	Nur für Wandmontage.	Wall mounting only.
 Usage intérieur uniquement.	Alleen voor binnengebruik.	Nur für den Innengebrauch.	Indoor use only.
 Protection contre la pénétration de corps supérieurs à 12mm. Sans protection contre l'eau.	Bescherming tegen het binnendringen van lichaam >12mm. Zonder bescherming tegen water.	Schutz gegen Eindringen von Körpern von mehr als 12mm. Ohne Schutz gegen Wasser.	Protected against the ingress of solid bodies greater 12 mm. No protection against the ingress of liquids.
 Protection contre une énergie de choc de 20 Joules.	Bescherming tegen een impact-energie van 20 Joule.	Schutz gegen eine Stoßenergie von 20 Joule.	Protection against an impact energy of 20 Joules.
 Produit à isolation principale qui comporte des dispositifs reliant l'ensemble de ses parties métalliques accessibles au conducteur de protection.	Product met hoofdisolatie, met een apparaat dat alle metalen delen die toegankelijk zijn met de beschermingsleiding verbindt.	Beleuchtung mit Hauptisolierung, mit einem Gerät welches alle seine Metallteile die zugänglich sind mit dem Schutzleiter verbindet.	Earth wire . Fixture equipped with primary insulation only.
 Faisceau 110°.	Lichtbundel 110°.	Strahlwinkel 110°.	Beam 110°.
 Homologation CE.	CE gekeurd.	CE Genehmigung.	Product in conformity CE.
 Indice de rendu des couleurs >90.	Kleurweergave-index >90.	Farbwiedergabeindex >90.	Colour rendering index >90.
 Risque photobiologique RG0	Fotobiologisch risico RG0	Photobiologisches Risiko RG0	Photobiological risk RG0
 Testé à 650°.	Getest bij 650°.	Getestet bei 650°.	Test on 650°.
 Installation sur surfaces normalement inflammables.	Installatie op normaal ontvlambare oppervlakken.	Installation auf normal entflammbaren Oberflächen.	Suitable for installation on normally flammable surfaces.
 Produit sous haute température en fonctionnement. Interdiction d'avoir des objets ou des parois proches pendant toute la durée de dégagement de chaleur. Même après extinction.	Product onder hoge temperatuur bij werking. Verbod voorwerpen of muren nabij te hebben gedurende de hele oververhitting, zelfs na uitdoving.	Produkt unter hoher Temperatur bei Betrieb. Verbot Gegenstände oder Wände in der Nähe zu haben während der ganzen Dauer der Überhitzung, auch nach dem Erlöschen.	Produkt emitting high temperature. Can not be installed too close of walls and objects even after extinction.
 Attention ! Risque d'électrocution. Extinction de la source électrique avant chaque manipulation.	Let op gevaar voor elektrocuteren. Afsluiten van de stroom voor iedere manipulatie.	Achtung Gefahr eines elektrischen Schlags. Stromquelle abschliessen bevor jede Manipulation.	Attention! Risk of electric shock. Switch off before any intervention on the luminaire.
 Alimentation incluse.	Voeding inbegrepen.	Stromversorgung einbegriffen.	Power supply included.
 A connecter à un courant alternatif de 230V.	Aan te sluiten op een AC-circuit van 230V.	An eine AC-Schaltung von 230 Volt an zu schliessen.	To connect to a 230V AC circuit.
 Garantie 5 ans.	5 jaar garantie.	5 Jahre Garantie.	5 years warranty.
 L'appareil doit être éliminé dans des centres de ramassage spécialisés.	Het toestel moet worden afgevoerd in een speciale collectie centra.	Das Gerät muss von einer speziellen Sammelstelle entsorgt werden.	Luminaire must be disposed in specialized collection center.
 Driver remplaçable par un électricien.	Driver vervangbaar door elektricien.	Driver von einem Elektriker austauschbar.	Replaceable control gear by an electrician.
 LED remplaçable par un électricien.	LED vervangbaar door elektricien.	LED von einem Elektriker austauschbar.	Replaceable LED light source by an electrician.
 <ul style="list-style-type: none"> Toutes les sources de chaleur (ampoules, transformateurs, convertisseurs, ...) doivent obligatoirement être suffisamment espacées et ventilées pour empêcher l'incendie. Veuillez nous contacter lors de cas particulier de montage. Ce document doit être conservé pendant toute la durée de vie du produit. Le produit ne sera ni échangé, ni repris en cas d'erreur de montage. INDIGO se réserve le droit de modifier les spécifications sans préavis. <p>Le luminaire doit être monté et installé par un professionnel et il sert uniquement à éclairer.</p>	<ul style="list-style-type: none"> Alle warmtebronnen (lampen, transformatoren, omvormers, ...) moeten voldoende worden geventileerd en op een voldoende afstand zijn om de brand te voorkomen. Neem contact met ons op in geval van speciale montage. Dit document moet worden bewaard voor de hele levensduur van het product. Het product wordt nog terug genomen, nog vervangen bij foutieve installatie. INDIGO behoudt zich het recht om specificaties te wijzigen zonder voorafgaande kennisgeving. <p>De armatuur moet worden gemonteerd en geïnstalleerd door vakmensen en dient alleen om te verlichten.</p>	<ul style="list-style-type: none"> Alle Wärmequellen (Lampen, Transformatoren, Umformer, ...) müssen ausreichend belüftet sein und einen genügenden Abstand haben um das Feuer zu verhindern. Bitte kontaktieren Sie uns bei einer speziellen Montage. Dieses Dokument muss für die ganze Lebensdauer des Produkts aufbewahrt werden. Das Produkt wird weder zurückgenommen noch umgetauscht bei falscher Installation. INDIGO behält das Recht für Spezifikationen, ohne vorherige Ankündigung, zu ändern. <p>Die Leuchte darf nur von Fachleuten montiert und installiert werden und dient nur zur Beleuchtung.</p>	<ul style="list-style-type: none"> All heat source (bulbs, transformers, converters, ...) are required to be sufficiently spaced and ventilated to prevent the fire. Please contact us in case of special installation. This document must be kept for the all lifetime of the product. The product can't be returned or exchanged following to installation error. INDIGO reserve the right to modify specifications without prior notice. <p>The fixture should be assembled and installed by professionals and used only to illuminate.</p>

PK30

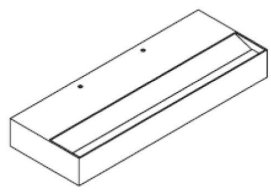
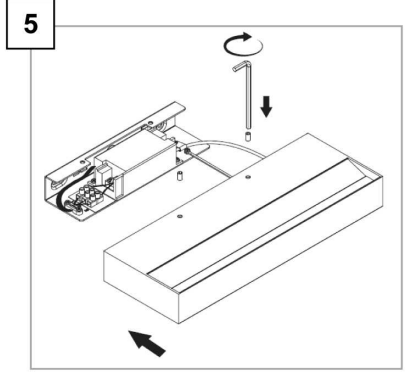
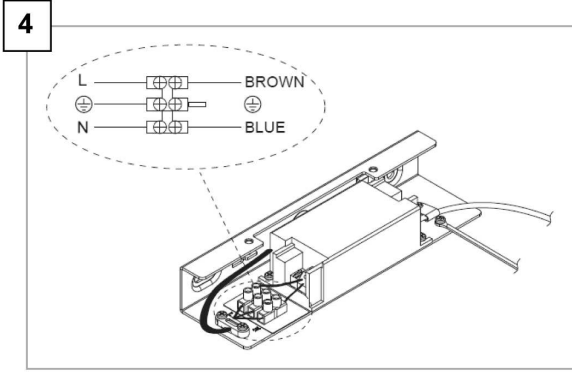
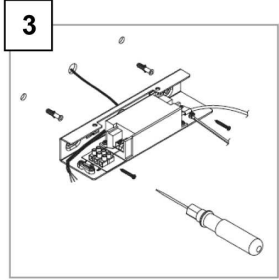
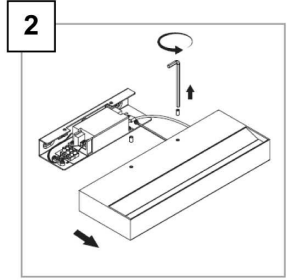
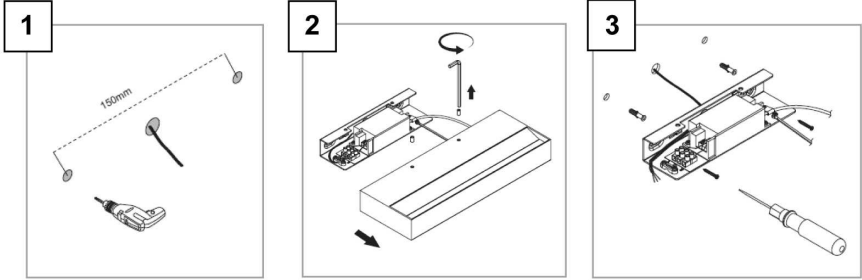
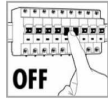
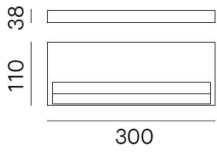

PK60

