

TIBLI R-B





















CODE	COULEUR	KLEUR	FARBE	COLOR	AC	DC	LED	T° (K)	LED Lumen
DO468WW05	NOIR MAT	MAT ZWART	SCHWARZ MATT	MATT BLACK	AC 230V	DC 350mA 3V	1,2W	3000K	115 Lm
DO468WW30	BLANC MAT	MAT WIT	WEISS MATT	MATT WHITE	AC 230V	DC 350mA 3V	1,2W	3000K	115 Lm

F Ce produit contient 1 source(s) lumineuse(s) d'efficacité énergétique G.

D Dieses Produkt enthält 1 Lichtquelle(n) mit G Energieeffizienz.

N Dit product bevat 1 lichtbron(nen) energiezuinig G.

E This product contains 1 light source(s) of energy efficiency G.

F	N	D	E
 Montage au plafond en encastré uniquement.	Inbouw Plafondmontage alleen.	Nur für Deckeneinbaumontage.	Recessed ceiling mounting only.
 Usage intérieur uniquement.	Alleen voor binnengebruik.	Nur für den Innengebrauch.	Indoor use only.
 Protection contre la pénétration de corps supérieurs à 12mm. Sans protection contre l'eau.	Bescherming tegen het binnendringen van lichaam >12mm. Zonder bescherming tegen water.	Schutz gegen Eindringen von Körpern von mehr als 12mm. Ohne Schutz gegen Wasser.	Protected against the ingress of solid bodies greater 12 mm. No protection against the ingress of liquids.
 Protection contre une énergie de choc de 0,70 Joule.	Bescherming tegen een impact-energie van 0,70 Joule.	Schutz gegen eine Stoßenergie von 0,70 Joule.	Protection against an impact energy of 0,70 Joule.
 Produit alimenté sous une très basse tension de sécurité (T.B.T.S) qui n'excède pas 50V (valeur efficace en courant alternatif).	Product aangedreven door een laag voltage (SELV) die niet groter is dan 50V (AC RMS).	Produkt geliefert mit einer niedrigen Spannung (SELV) die 50 V nicht überschreitet (RMS AC).	Product can be connected to low-voltage systems. A safety extra low voltage luminaire in which voltages higher than those of SELV are not generated.
 Diamètre de perçement pour insérer le luminaire. (25mm)	Gatdiameter voor de armatuur in te voegen. (25mm)	Gatdiameter voor de armatuur in te voegen. (25 mm)	Hole cut to insert luminaire (25 mm)
 Faisceau 20°.	Lichtbundel 20°.	Strahlwinkel 20°.	Beam 20°.
 Homologation CE.	CE gekeurd.	CE Genehmigung.	Product in conformity CE.
 UGR inférieur à 19.	UGR lager dan 19.	UGR niedriger als 19.	UGR below 19.
 Risque photobiologique RG1	Fotobiologisch risico RG1	Photobiologisches Risiko RG1	Photobiological risk RG1
 Testé à 650°.	Getest bij 650°.	Getestet bei 650°.	Test on 650°.
 Le produit ne peut pas être recouvert après montage, même par un isolant.	De armatuur kan na de installatie niet bedekt worden, zelfs door een isolatie.	Das Produkt kann nach der Installation nicht abgedeckt werden, auch nicht durch eine Isolation.	Product can not be covered after installation even with insulation.
 Installation sur surfaces normalement inflammables.	Installatie op normaal ontvlambare oppervlakken.	Installation auf normal entflammbaren Oberflächen.	Suitable for installation on normally flammable surfaces.
 Attention ! Risque d'électrocution. Extinction de la source électrique avant chaque manipulation.	Let op gevaar voor elektrocuteren. Afsluiten van de stroom voor iedere manipulatie.	Achtung Gefahr eines elektrischen Schlags. Stromquelle abschliessen bevor jede Manipulation.	Attention! Risk of electric shock. Switch off before any intervention on the luminaire.
 Alimentation non incluse.	Voeding niet inbegrepen.	Stromversorgung nicht einbegriffen.	Power supply not included.
 Branchement en série.	Serie schakeling.	Reihenschaltung.	Series connection.
 A connecter à une alimentation Led en courant constant de 350mA DC.	Aan te sluiten op een constante stroom Led voeding van 350mA DC.	Verbindung zu einem Power-LED-Konstantstrom 350mA DC.	Connect to a constant current Led power supply of 350mA DC.
 Garantie 5 ans.	5 jaar garantie.	5 Jahre Garantie.	5 years warranty.
 L'appareil doit être éliminé dans des centres de ramassage spécialisés.	Het toestel moet worden afgevoerd in een speciale collectie centra.	Das Gerät muss von einer speziellen Sammelstelle entsorgt werden.	Luminaire must be disposed in specialized collection center.
 LED remplaçable par un électricien.	LED vervangbaar door elektricien.	LED von einem Elektriker austauschbar.	Replaceable LED light source by an electrician.

<p> • Toutes les sources de chaleur (ampoules, transformateurs, convertisseurs, ...) doivent obligatoirement être suffisamment espacées et ventilées pour empêcher l'incendie. Veuillez nous contacter lors de cas particulier de montage.</p> <p>• Ce document doit être conservé pendant toute la durée de vie du produit.</p> <p>• Le produit ne sera ni échangé, ni repris en cas d'erreur de montage.</p> <p>• INDIGO se réserve le droit de modifier les spécifications sans préavis.</p> <p>Le luminaire doit être monté et installé par un professionnel et il sert uniquement à éclairer.</p>	<p>• Alle warmtebronnen (lampen, transformatoren, omvormers, ...) moeten voldoende worden geventileerd en op een voldoende afstand zijn om de brand te voorkomen. Neem contact met ons op in geval van speciale montage.</p> <p>• Dit document moet worden bewaard voor de hele levensduur van het product.</p> <p>• Het product wordt nog terug genomen, nog vervangen bij foutieve installatie.</p> <p>• INDIGO behoudt zich het recht om specificaties te wijzigen zonder voorafgaande kennisgeving.</p> <p>De armatuur moet worden gemonteerd en geïnstalleerd door vakmensen en dient alleen om te verlichten.</p>	<p>• Alle Wärmequellen (Lampen, Transformatoren, Umformer, ...) müssen ausreichend belüftet sein und einen genügenden Abstand haben um das Feuer zu verhindern. Bitte kontaktieren Sie uns bei einer speziellen Montage.</p> <p>• Dieses Dokument muss für die ganze Lebensdauer des Produkts aufbewahrt</p> <p>• Das Produkt wird weder zurückgenommen noch umgetauscht bei falscher Installation.</p> <p>• INDIGO behält das Recht für Spezifikationen, ohne vorherige Ankündigung, zu ändern.</p> <p>Die Leuchte darf nur von Fachleuten montiert und installiert werden und dient nur zur Beleuchtung.</p>	<p>• All heat source (bulbs, transformers, converters, ...) are required to be sufficiently spaced and ventilated to prevent the fire. Please contact us in case of special installation.</p> <p>• This document must be kept for the all lifetime of the product.</p> <p>• The product can't be returned or exchanged following to installation error.</p> <p>• INDIGO reserve the right to modify specifications without prior notice.</p> <p>The fixture should be assembled and installed by professionals and used only to illuminate.</p>
---	--	---	--

1

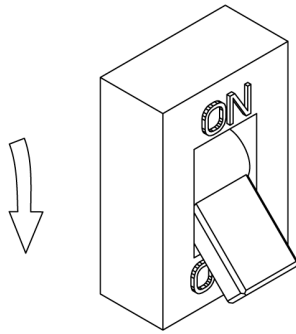

2

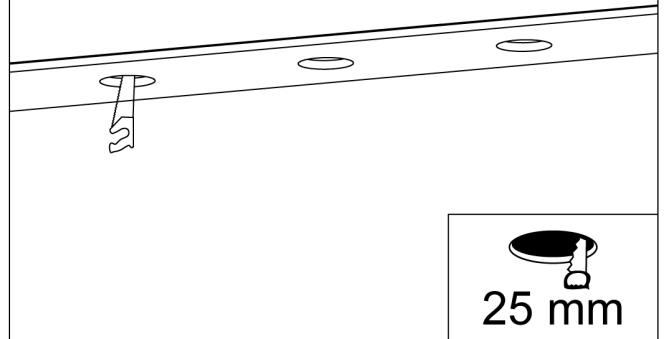

3

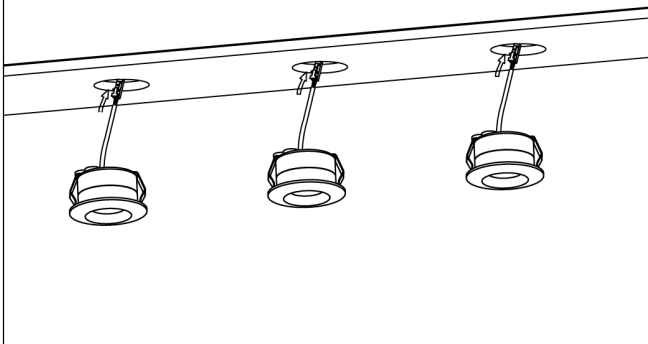

4

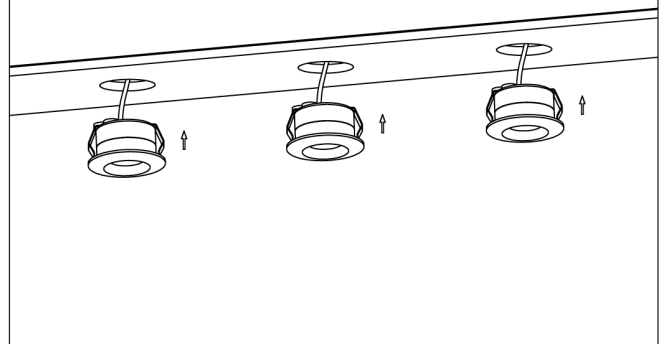

5

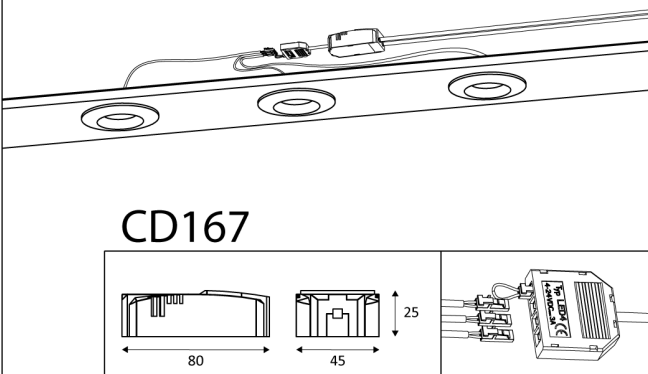

6

