

### LINEAR 2 P



















CODE	COULEUR	KLEUR	FARBE	COLOR	AC	LED	T° (K)	LED Lumen
CL10905	NOIR MAT	MAT ZWART	SCHWARZ MATT	MATT BLACK	AC 230V	21W 32W	3000-3500-4000K	3350 Lm (4000K) 5100 Lm (4000K)
CL10930	BLANC MAT	MAT WIT	WEISS MATT	MATT WHITE	AC 230V	21W 32W	3000-3500-4000K	3350 Lm (4000K) 5100 Lm (4000K)
CL10905DA	NOIR MAT	MAT ZWART	SCHWARZ MATT	MATT BLACK	AC 230V	21W 32W	3000-3500-4000K	3350 Lm (4000K) 5100 Lm (4000K)
CL10930DA	BLANC MAT	MAT WIT	WEISS MATT	MATT WHITE	AC 230V	21W 32W	3000-3500-4000K	3350 Lm (4000K) 5100 Lm (4000K)

F Ce produit contient 432 source(s) lumineuse(s) d'efficacité énergétique F(05), E(30).

D Dieses Produkt enthält 432 Lichtquelle(n) mit F(05), E(30) energieeffizient.

N Dit product bevat 432 lichtbron(ne)n met energiezuinig F(05), E(30).

E This product contains 432 light source(s) with energy efficiency F(05), E(30).

F	N	D	E
 Montage en suspension.	Pendelmontage.	Nur für Aufhängmontage.	Suspended mounting only.
 Usage intérieur uniquement.	Alleen voor binnengebruik.	Nur für den Innengebrauch.	Indoor use only.
 Protection contre la pénétration de corps supérieurs à 12mm. Sans protection contre l'eau.	Bescherming tegen het binnendringen van lichaam >12mm. Zonder bescherming tegen water.	Schutz gegen Eindringen von Körpern von mehr als 12mm. Ohne Schutz gegen Wasser.	Protected against the ingress of solid bodies greater 12 mm. No protection against the ingress of liquids.
 Protection contre une énergie de choc de 0,15 Joule.	Bescherming tegen een impact-energie van 0,15 Joule.	Schutz gegen eine Stoßenergie von 0,15 Joule.	Protection against an impact energy of 0,15 Joule.
 Produit à isolation principale qui comporte des dispositifs reliant l'ensemble de ses parties métalliques accessibles au conducteur de protection.	Product met hoofdisolatie, met een apparaat dat alle metalen delen die toegankelijk zijn met de beschermingsleiding verbindt.	Beleuchtung mit Hauptisolierung, mit einem Gerät welches alle seine Metallteile die zugänglich sind mit dem Schutzleiter verbindet.	Earth wire . Fixture equipped with primary insulation only.
 Faisceau 75°.	Lichtbundel 75°.	Strahlwinkel 75°.	Beam 75°.
 Homologation CE.	CE gekeurd.	CE Genehmigung.	Product in conformity CE.
 Température de couleur à sélectionner.	Keuze van kleurtemperatuur.	Wahl der Farbtemperatur.	Selectable colour temperature.
 UGR inférieure à 19.	UGR lager dan 19.	UGR niedriger als 19.	UGR below 19.
 Risque photobiologique RG1	Fotobiologisch risico RG1	Photobiologisches Risiko RG1	Photobiological risk RG1
 Testé à 650°.	Getest bij 650°.	Getestet bei 650°.	Test on 650°.
 Produit sous haute température en fonctionnement. Interdiction d'avoir des objets ou des parois proches pendant toute la durée de dégagement de chaleur. Même après extinction.	Product onder hoge temperatuur bij werking. Verbod voorwerpen of muren nabij te hebben gedurende de hele oververhitting, zelfs na uitdoving.	Produkt unter hoher Temperatur bei Betrieb. Verbot Gegenstände oder Wände in der Nähe zu haben während der ganzen Dauer der Überhitzung, auch nach dem Erlöschen.	Product emitting high temperature. Can not be installed too close of walls and objects even after extinction.
 Attention ! Risque d'électrocution. Extinction de la source électrique avant chaque manipulation.	Let op gevaar voor elektrocuteren. Afsluiten van de stroom voor iedere manipulatie.	Achtung Gefahr eines elektrischen Schlags. Stromquelle abschliessen bevor jede Manipulation.	Attention! Risk of electric shock. Switch off before any intervention on the luminaire.
 Alimentation incluse.	Voeding inbegrepen.	Stromversorgung einbegriffen.	Power supply included.
 A connecter à un courant alternatif de 230V.	Aan te sluiten op een AC-circuit van 230V.	An eine AC-Schaltung von 230 Volt an zu schliessen.	To connect to a 230V AC circuit.
 Garantie 5 ans.	5 jaar garantie.	5 Jahre Garantie.	5 years warranty.
 L'appareil doit être éliminé dans des centres de ramassage spécialisés.	Het toestel moet worden afgevoerd in een speciale collectie centra.	Das Gerät muss von einer speziellen Sammelstelle entsorgt werden.	Luminaire must be disposed in specialized collection center.
 Driver remplaçable par un électricien.	Driver vervangbaar door elektricien.	Driver von einem Elektriker austauschbar.	Replaceable control gear by an electrician.
 LED non remplaçable.	Niet-vervangbare lichtbron.	Lichtquelle nicht austauschbar.	Non-replaceable light source.

- |   |  |   |   |
|---|--|---|---|
| <p> • Toutes les sources de chaleur (ampoules, transformateurs, convertisseurs, ...) doivent obligatoirement être suffisamment espacées et ventilées pour empêcher l'incendie. Veuillez nous contacter lors de cas particulier de montage.</p> <p>• Ce document doit être conservé pendant toute la durée de vie du produit.</p> <p>• Le produit ne sera ni échangé, ni repris en cas d'erreur de montage.</p> <p>• INDIGO se réserve le droit de modifier les spécifications sans préavis.</p> <p><b>Le luminaire doit être monté et installé par un professionnel et il sert uniquement à éclairer.</b></p> | <p>• Alle warmtebronnen (lampen, transformatoren, omvormers, ...) moeten voldoende worden geventileerd en op een voldoende afstand zijn om de brand te voorkomen. Neem contact met ons op in geval van speciale montage.</p> <p>• Dit document moet worden bewaard voor de hele levensduur van het product.</p> <p>• Het product wordt nog terug genomen, nog vervangen bij foutieve installatie.</p> <p>• INDIGO behoudt zich het recht om specificaties te wijzigen zonder voorafgaande kennisgeving.</p> <p><b>De armatuur moet worden gemonteerd en geïnstalleerd door vakmensen en dient alleen om te verlichten.</b></p> | <p>• Alle Wärmequellen (Lampen, Transformatoren, Umformer, ...) müssen ausreichend belüftet sein und einen genügenden Abstand haben um das Feuer zu verhindern. Bitte kontaktieren Sie uns bei einer speziellen Montage.</p> <p>• Dieses Dokument muss für die ganze Lebensdauer des Produkts aufbewahrt werden.</p> <p>• Das Produkt wird weder zurückgenommen noch umgetauscht bei falscher Installation.</p> <p>• INDIGO behält das Recht für Spezifikationen, ohne vorherige Ankündigung, zu ändern.</p> <p><b>Die Leuchte darf nur von Fachleuten montiert und installiert werden und dient nur zur Beleuchtung.</b></p> | <p>• All heat source (bulbs, transformers, converters, ...) are required to be sufficiently spaced and ventilated to prevent the fire.</p> <p>• This document must be kept for the all lifetime of the product.</p> <p>• The product can't be returned or exchanged following to installation error.</p> <p>• INDIGO reserve the right to modify specifications without prior notice.</p> <p><b>The fixture should be assembled and installed by professionals and used only to illuminate.</b></p> |
|---|--|---|---|

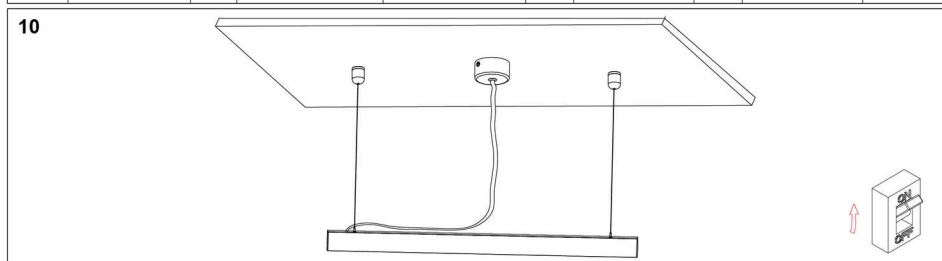
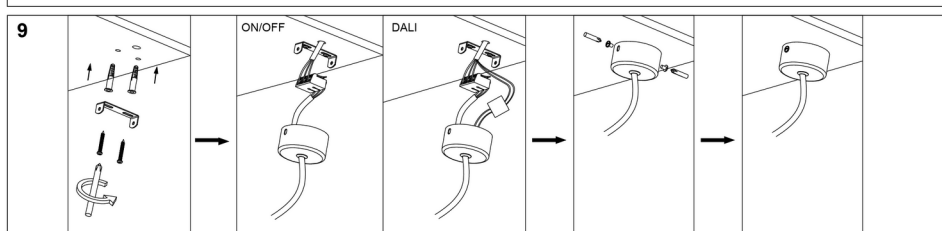
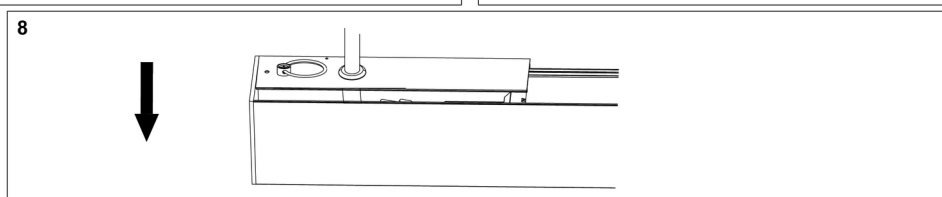
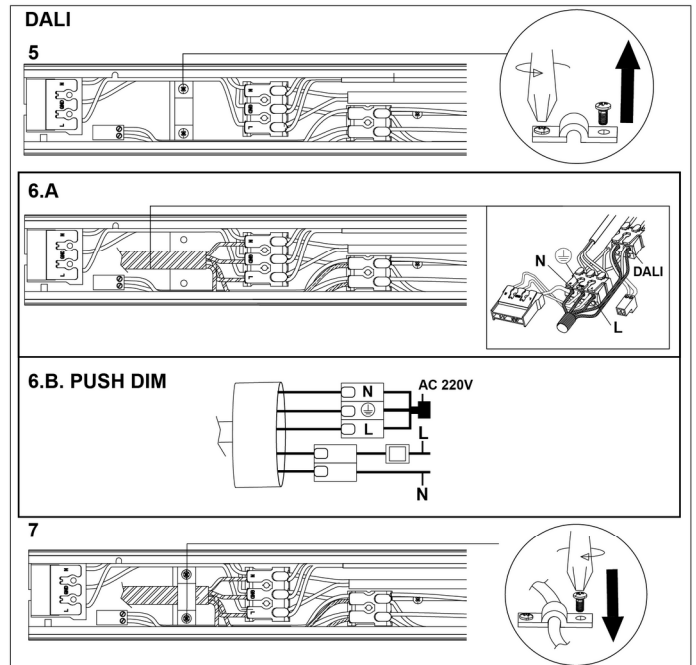
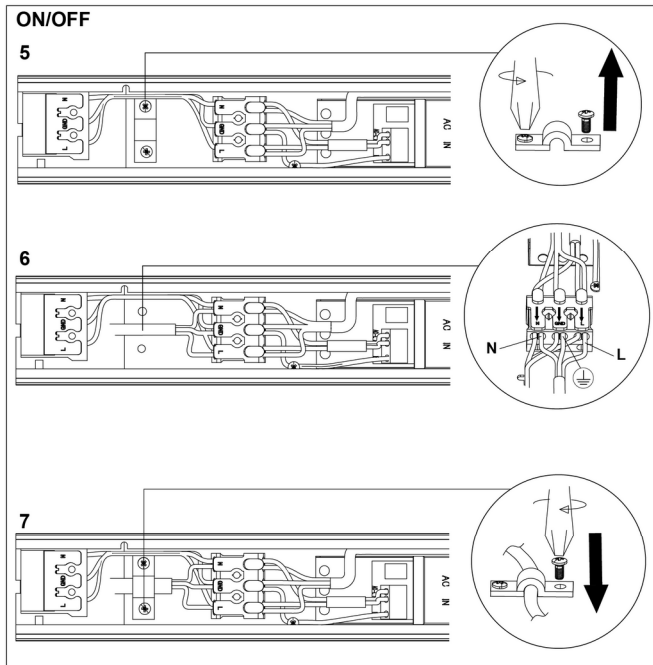
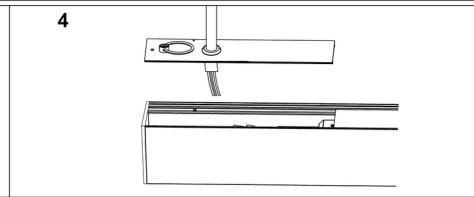
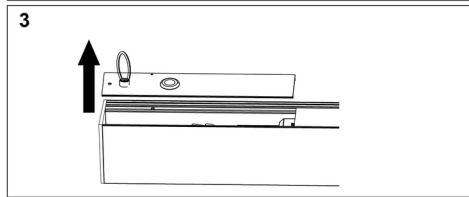
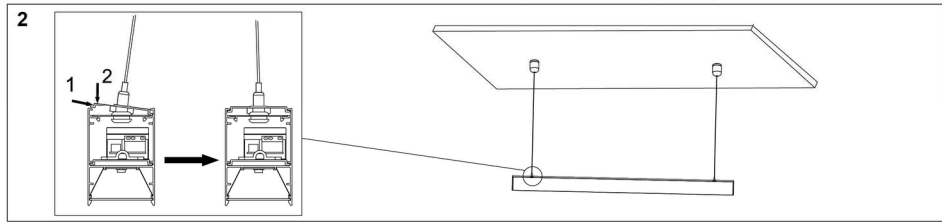
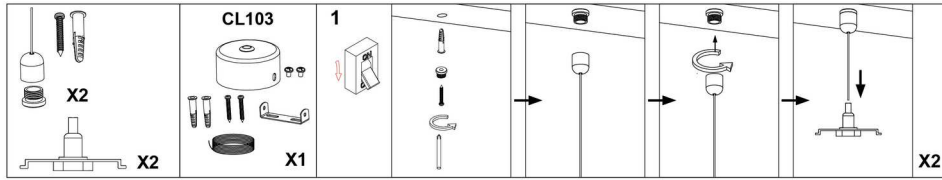

LIGNES CONTINUES - DOORLOPENDE LIJN - LICHTLEISTEN - CONTINUOUS LINES

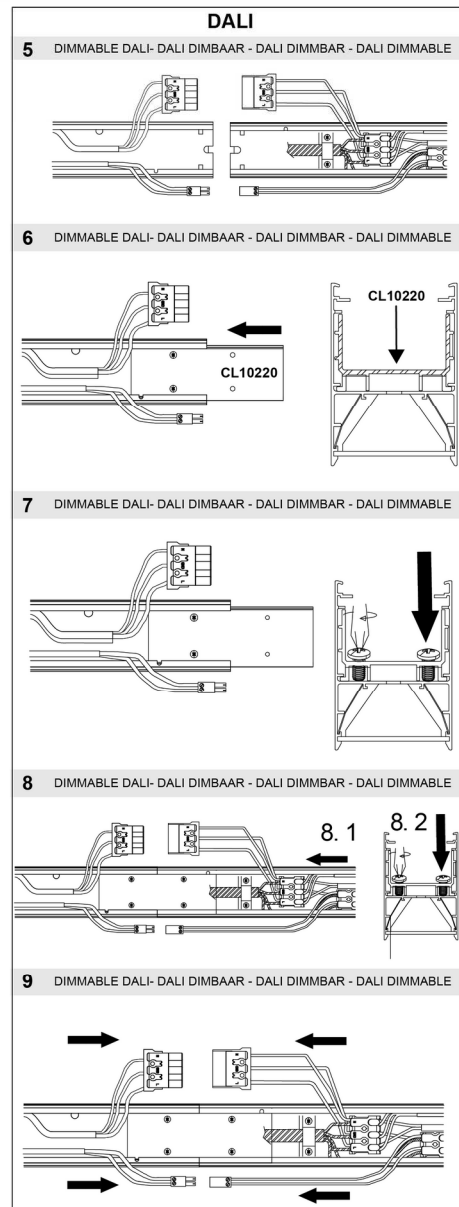
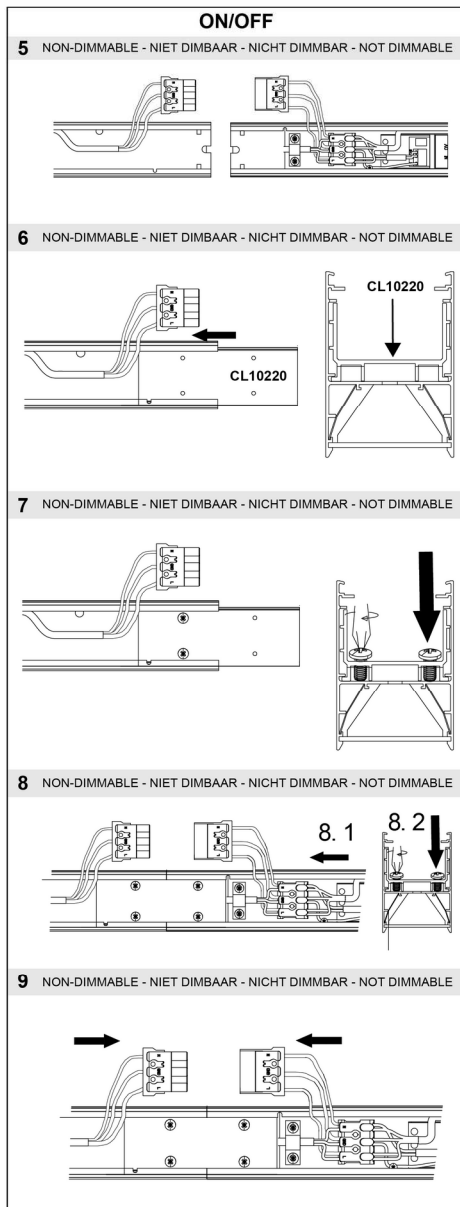
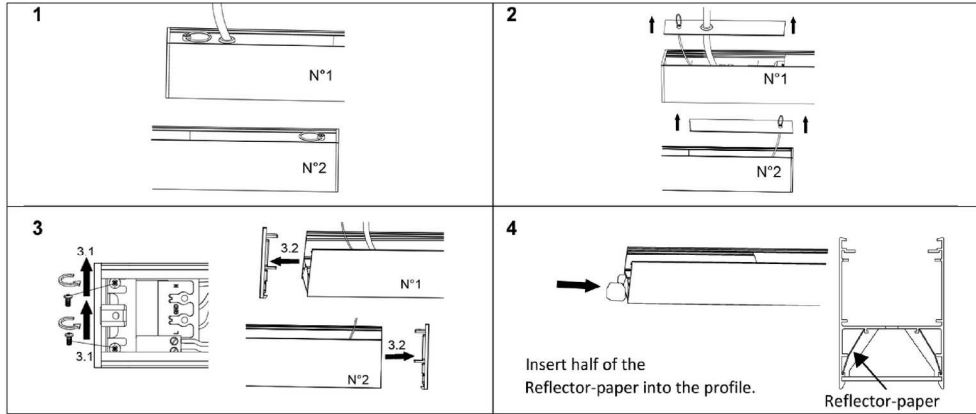
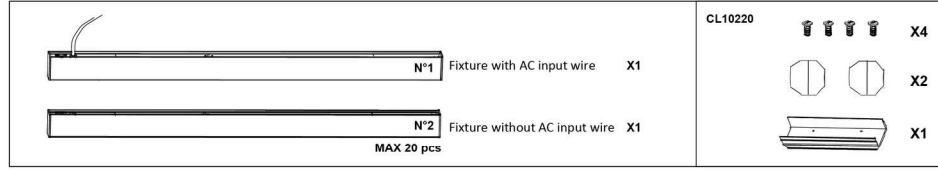

10 NON-DIMMABLE - NIET DIMBAAR - NICHT DIMMBAR - NOT DIMMABLE

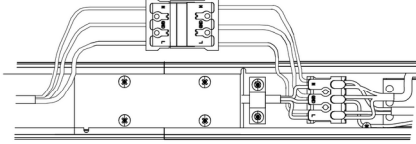

11 NON-DIMMABLE - NIET DIMBAAR - NICHT DIMMBAR - NOT DIMMABLE

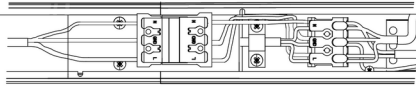

10 DIMMABLE DALI- DALI DIMBAAR - DALI DIMMBAR - DALI DIMMABLE

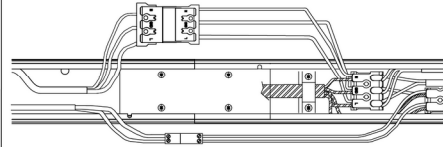

11 DIMMABLE DALI- DALI DIMBAAR - DALI DIMMBAR - DALI DIMMABLE

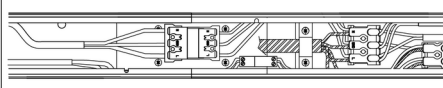

12

