

OTIS 2 P

- Linear hanging light.
- UP, down or up and down lighting as desired with a switch at the back of the luminaire.
- Low luminance reflector (down lighting) and polycarbonate diffuser (up lighting).
- Supplied with black or white suspension cables (adjustable up to 1.50m max).
- Dimmable converter built in the device.
- Compatible with start and end-of-phase dimmer.

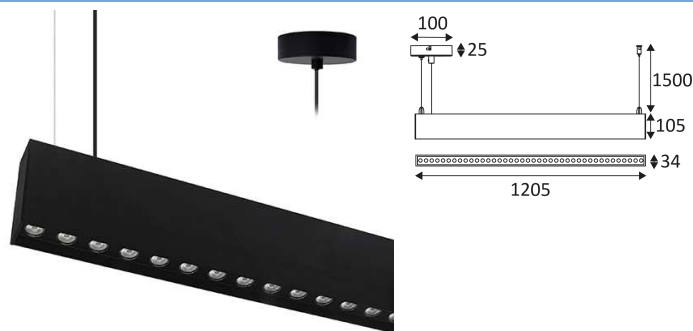

















This product contains 2 light source(s) of energy efficiency D.

CODE	COLOR	MATERIAL	AC	LED	T° (K)	LED Lumen	System Lumen	α
SU168WW05	MATT BLACK	ALUMINIUM	AC 230V	30W+5W	3000K	3850+850 Lm	3525+645 Lm	60° / 110°
SU168WW30	MATT WHITE	ALUMINIUM	AC 230V	30W+5W	3000K	3850+850 Lm	3525+645 Lm	60° / 110°
SU168NW05	MATT BLACK	ALUMINIUM	AC 230V	30W+5W	4000K	4350+900 Lm	3870+590 Lm	60° / 110°
SU168NW30	MATT WHITE	ALUMINIUM	AC 230V	30W+5W	4000K	4350+900 Lm	3870+590 Lm	60° / 110°



MATT BLACK

MATT WHITE

-  Suspended mounting only.
-  Indoor use only.
-  Protected against the ingress of solid bodies greater 12 mm. No protection against the ingress of liquids.
-  Protection against an impact energy of 1 Joule.
-  Earth wire . Fixture equipped with primary insulation only.
-  Beam 60°.
-  Beam 110°.
-  Product in conformity CE.
-  CRI>80
-  LED specifications.
-  UGR below 19.
-  Photobiological risk RG1
-  Test on 750°.
-  Power supply included.
-  The product is dimmable.
-  5 years warranty.
-  Photometric data available on our website: www.indigo-lighting.com

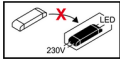

Non-replaceable control gear.

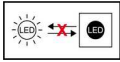

Non-replaceable light source.